











Injection Technique and Mining

Injektionstechnik und Bergbau



- 4  Company Profile
Unternehmensprofil
- 5  Product Portfolio
Produkt-Portfolio
- 6  Injectionpumps, Measurement devices
Injektionspumpen, Messtechnik
- 8  Spare and wear parts
Ersatz- und Verschleißteile
- 10  Mixing units, Accessories
Mischreinrichtungen, Zubehör
- 12  Hoses
Schläuche
- 13  Steck-O, Valves, Accessories
Steck-O, Ventile, Zubehör
- 18  Boreholeseals, Packers, Anchors, Accessories
Bohrlochverschlüsse, Packer, Anker, Zubehör
- 21  Feederpipes, Injection lances
Beschickungsrohre, Rammlanzen
- 22  Air Mover, Roofbolter
Wetterdüsen, Ankerbohrsäulen



mts Perforator - tradition meets latest technology

mts Perforator is continuing the 100 years old tradition of the Schmidt, Kranz Group (SK) which began building mining technique and tunneling systems in the 19th century. mts Perforator is part of this efficient and well-established Group together with various other manufacturing companies. mts Perforator combines proven tradition with continuous innovation, and offers a wide range of high-quality products. In addition, the cooperation within the SK Group enables all of the participating parties to benefit from synergies within the Group: an advantage that mts Perforator passes directly on to its customers.



Quality made in Germany

Diligence and precision are characteristics of mts Perforator technology and machines. The experienced team continuously improves the quality and operation mode of the systems, as well as developing completely new solutions for changing circumstances and surroundings. mts Perforator combines flexibility and cost efficiency with the highest service quality. Furthermore mts Perforator highly values every customer's wishes and strongly focuses on personal assistance to establish a satisfied long-term relationship. This is achieved by a small hierarchy, lean structures, 180 qualified employees and an efficient management.



Johann-Christian von Behr

Your solution

The main objective of mts Perforator is to find a balance between customer requirements and the requirements of nature and the environment. The technologically advanced products of mts Perforator allow to simplify people's life worldwide and use trenchless technology to conserve resources and focus on sustainability. If you are looking for a partner who offers the latest technology adapted to your individual requirements and actively supports you by planning and executing your projects, then is mts Perforator the right choice for optimal product solutions.



Gilbert Kimpel



Injection Technique | Injektionstechnik

Injection Pumps, Grouting Pumps, Accessories, Flow Measurement Units, Feeder Pipes (steel or plastic), Borehole Seals, Reuseable Single and Double Packer, Injection Tube with bolting Effect, Foam Generation Systems

Injektionspumpen, Zementierpumpen, Zubehör, Durchflussmessgeräte, Beschickungsrohre aus Stahl oder Kunststoff, Bohrlochverschlüsse, Wiederverwendbare Einzel- und Doppelpacker, Injektionsrohr mit Ankerwirkung, Schaumgeneratoren

Pneumatisch angetriebene
2-Komponenten
Kolbenpumpe
Typ: S35 PU-N
Artikel-Nr.: 9600.0250



Air driven
2-Component
Piston pump
Type: S35 PU-N
Order code: 9600.0250

Wheel set
Order code: 9600.0267

Radsatz
Artikel-Nr.: 9600.0267

Pneumatisch angetriebene
2-Komponenten
Kolbenpumpe
Typ: GSF 35-2 PU-N
Artikel-Nr.: 9600.0239

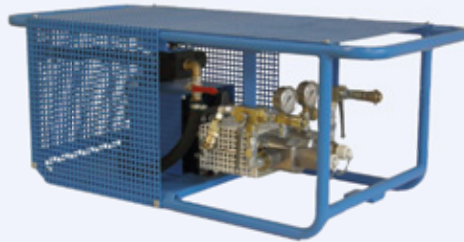

Air driven
2-Component
Piston pump
Type: GSF 35-2 PU-N
Order code: 9600.0239

Wheel set
Order code: 9600.0267

Radsatz
Artikel-Nr.: 9600.0267

Pneumatisch angetriebene
2-Komponenten
Kolbenpumpe
Typ: GX 45 PU-N
Artikel-Nr.: 9600.0238

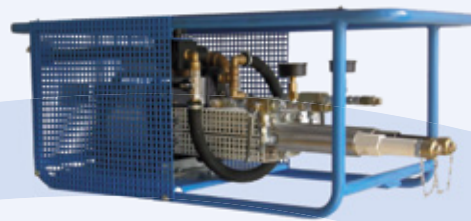

Air driven
2-Component
Piston pump
Type: GX 45 PU-N
Order code: 9600.0238

Wheel set
Order code: 9600.0267

Radsatz
Artikel-Nr.: 9600.0267

Pneumatisch angetriebene
2-Komponenten
Kolbenpumpe
Typ: DP 40 PU-N
Artikel-Nr.: 7800.0178



Air driven
2-Component
Piston pump
Type: DP 40 PU-N
Order code: 7800.0178

Reducer DN20 -> DN10
Order code: 1060.0685

Reduzierung DN20 -> DN10
Artikel- Nr.: 1060.0685

Hydraulisch angetriebene
2-Komponenten
Kolbenpumpe
Typ: HIP 5,5/150



Hydraulic driven
2-Component
Piston pump
Type: HIP 5,5/150

Order code: 9600.0132

Artikel-Nr.: 9600.0132

Pneumatisch angetriebene
2-Komponenten
Zahnradpumpe
Typ: PGP 30/40
Artikel-Nr.: 9600.0086

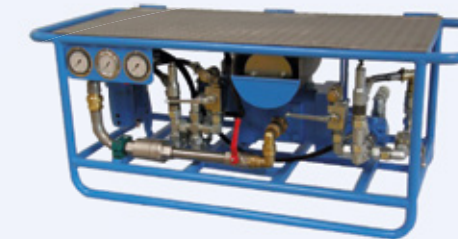

Air driven
2-Component
Gear pump
Type: PGP 30/40
Order code: 9600.0086

Ersatz Zahnradpumpe 1:1
Artikel-Nr.: 9600.0095

Spare gear pump 1:1
Order code: 9600.0095

Pneumatisch angetriebene
2-Komponenten
Zahnradpumpe
Typ: PGP 30/40 LC
Artikel-Nr.: 9600.0162

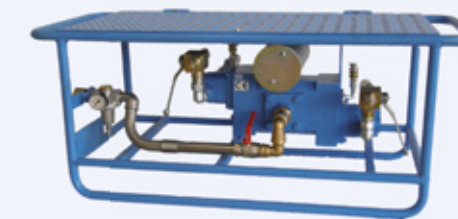

Air driven
2-Component
Gear pump
Type: PGP 30/40 LC
Order code: 9600.0162

Ersatz Zahnradpumpe 1:1
Artikel-Nr.: 9600.0095

Spare gear pump 1:1
Order code: 9600.0095

Pneumatisch angetriebene
2-Komponenten
Zahnradpumpe
Typ: PGP 30/40-Phenol
Artikel-Nr.: 9600.0287

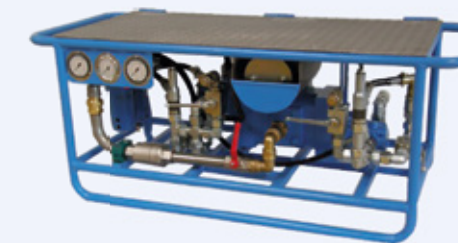

Air driven
2-Component
Gear pump
Type: PGP 30/40-Phenol
Order code: 9600.0287

Artikel-Nr.: 9600.0287

Pneumatisch angetriebene
1-Komponenten
Kolbenpumpe
Typ: GX 35 V
Artikel-Nr.: 3320.0832



Air driven
1-Component
Piston pump
Type: GX 35 V
Order code: 3320.0832

Artikel-Nr.: 3320.0832

GX 45 komplett Paket
inkl. Ersatzteile
& Zubehör



GX 45 complete Set
incl. spare parts
& accessories
Order code: 0000.0000

Artikel-Nr.: 0000.0000

Medientanks kpl.
Artikel-Nr.: 7800.0069



Media container compl.
Order code.: 7800.0069

Saugventil kpl.
für Typ:
S 35 PU (schwarz + weiß)
GSF 35-2 PU (schwarz)
DP 40 PU (schwarz)
Artikel-Nr.: 3620.0384



Suction valve compl.
for type:
S 35 PU (black + white)
GSF 35-2 PU (black)
DP 40 PU (black)
Order code: 3620.0384

Saugventil kpl.
für Typ:
GSF 35- 2 PU (weiß)
DP 40 PU (weiß)
GX 45 PU (schwarz + weiß)
Artikel-Nr.: 3620.0557



Suction valve compl.
for type:
GSF 35-2 PU (white)
DP 40 PU (white)
GX 45 PU (black + white)
Order code: 3620.0557

Druckventil kpl.
für Typ:

S 35 PU
Artikel-Nr.: 3620.2961
DP 40 PU
Artikel-Nr.: 3620.0382
PGP 30/40
Artikel-Nr.: 9600.0110



Pressure valve compl.
for type:

S 35 PU
Order code: 3620.2961
DP 40 PU
Order code: 3620.0382
PGP 30/40
Order code: 9600.0110

Verschlusskappe
RD 32x1/8" innen
mit verz. Kette
und Sicherungsring
Artikel-Nr.: 1270.0024



Locking cap
RD 32x1/8" female
with galvanized chain
and retaining ring
Order code: 1270.0024

Dichtsatz Steuerschieber

S 35 PU
Artikel- Nr.: 3640.0112
GX 35 PU / GX 45 PU
Artikel- Nr.: 3620.2029
DP 40 PU
Artikel- Nr.: 3620.2029
GSF 35 PU
Artikel- Nr.: 7800.0224



Seal kit Spool

S 35 PU
Order code: 3640.0112
GX 35 PU / GX 45 PU
Order code: 3620.2029
DP 40 PU
Order code: 3620.2029
GSF 35 PU
Order code: 7800.0224

Dichtsatz Hochdruckteil
S 35 PU
Artikel- Nr.: 9600.0208
GX 45 PU
Artikel- Nr.: 9600.0044
DP 40 PU
Artikel- Nr.: 3620.1492
GX 35 PU
Artikel- Nr.: 3620.2155
GSF 35 PU
Artikel- Nr.: 3620.1304



Seal kit High Pressure
S 35 PU
Order code: 9600.0208
GX 45 PU
Order code: 9600.0044
DP 40 PU
Order code: 3620.1492
GX 35 PU
Order code: 3620.2155
GSF 35 PU
Order code: 3620.1304

Dichtsatz Luftantriebsteil
S 35 PU
Artikel- Nr.: 3640.0827
GX 45 PU
Artikel- Nr.: 9600.0045
DP 40 PU
Artikel- Nr.: 3620.1891
GX 35 PU
Artikel- Nr.: 3620.1742
GSF 35 PU
Artikel- Nr.: 3620.1459



Seal kit air drive
S 35 PU
Order code: 3640.0827
GX 45 PU
Order code: 9600.0045
DP 40 PU
Order code: 3620.1891
GX 35 PU
Order code: 3620.1742
GSF 35 PU
Order code: 3620.1459

Mischeinrichtung kplt.

DN 10 - 10
Artikel-Nr.: 7800.0214
DN 12 - 12
Artikel-Nr.: 9600.0023



Mixer unit compl.

DN 10 - 10
Order code: 7800.0214
DN 12 - 12
Order code: 9600.0023

Mischeinrichtung gewinkelt kplt.

DN 10 - 10
Artikel-Nr.: 9600.0014
DN 12 - 12
Artikel-Nr.: 9600.0020



Mixing unit angulated
compl.

DN 10 - 10
Order code: 9600.0014
DN 12 - 12
Order code: 9600.0020

Manometer f. Mischeinrichtung
inkl. Adapter und T-Stück

DN 10
Artikel-Nr.: 9600.0017
DN 12
Artikel-Nr.: 9600.0024



Gauge f. mixing unit
incl. adapter
anc T-piece

DN 10
Order code: 9600.0017
DN 12
Order code: 9600.0024

Mischrohr
Innendurchmesser 12mm,
Länge 350mm

DN 10
Artikel-Nr.: 9500.0024
DN 12
Artikel-Nr.: 9500.0034



Injectionpipe
inner diameter 12mm,
length 350mm

DN 10
Order code: 9500.0024
DN 12
Order code: 9500.0034

Statikmischer

11mm x 136mm
Artikel-Nr.: 9600.0000



Mixing spiral

11mm x 136mm
Order code: 9600.0000

Rücklaufstutzen aus VA
für 1000 Ltr. Behälter

Artikel-Nr.: 7800.0076

Filtergehäuse mit
Trockenpatrone

Artikel-Nr.: 7800.0077



Return Connection VA
for 1000 ltr. Tank

Order Code: 7800.0076

Dry- type filtercartridge

Order Code: 7800.0077

HD-Schlauch DN 10

2m Artikel-Nr.: 1377.0846
5m Artikel-Nr.: 1377.0827
10m Artikel-Nr.: 1377.0828
15m Artikel-Nr.: 1377.0848



HP - Hose DN 10

2m Order code: 1377.0846
5m Order code: 1377.0827
10m Order code: 1377.0828
15m Order code: 1377.0848

Kupplungsklammer
Steck - O

DN 10
Artikel-Nr.: 1060.0013
DN 12
Artikel-Nr.: 1060.0014
DN 20
Artikel-Nr.: 1060.0015



Coupling crank
SO - coupling

DN 10
Order code: 1060.0013
DN 12
Order code: 1060.0014
DN 20
Order code: 1060.0015

HD-Schlauch DN 12

2m Artikel-Nr.: 1377.0906
5m Artikel-Nr.: 1377.0907
10m Artikel-Nr.: 1377.0908
15m Artikel-Nr.: 1377.0909



HP - Hose DN 12

2m Order code: 1377.0906
5m Order code: 1377.0907
10m Order code: 1377.0908
15m Order code: 1377.0909

Kugelhahn drehbar
Steck - O

DN 10
Artikel-Nr.: 1080.0049
DN 12
Artikel-Nr.: 1080.0088
DN 20
Artikel-Nr.: 1080.0065



Ball valve rotating
SO - coupling

DN 10
Order code: 1080.0049
DN 12
Order code: 1080.0088
DN 20
Order code: 1080.0065

HD-Schlauch DN 20

2m Artikel-Nr.: 1377.0910
5m Artikel-Nr.: 1377.0911
10m Artikel-Nr.: 1377.0912
15m Artikel-Nr.: 1377.0913



HP - Hose DN 20

2m Order code: 1377.0910
5m Order code: 1377.0911
10m Order code: 1377.0912
15m Order code: 1377.0913

Kugelhahn drehbar
Steck - O
m. Sicherheitsgriff

DN 10
Artikel-Nr.: 1080.0056
DN 12
Artikel-Nr.: 1080.0064

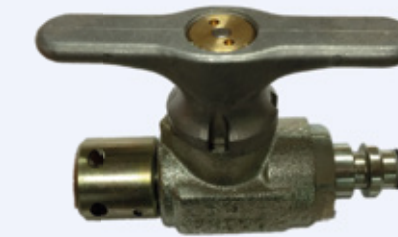

Ball valve rotating
SO - coupling
w. safety knob

DN 10
Order code: 1080.0056
DN 12
Order code: 1080.0064

Saugschlauch
mit beidseitig Überwurfmutter RD
32x1/8"

Artikel-Nr.: 7800.0174

Saugschlauch mit Fußventil

Artikel-Nr.: 9600.0332



Suction hose
with connection nuts
RD 32x1/8"
Order code: 7800.0174

Suction hose with foot valve
Order-Code: 9600.0332

Rückschlagventil
Steck - O

DN 10
Artikel-Nr.: 1080.0057
DN 12
Artikel-Nr.: 1080.0062
DN 20
Artikel-Nr.: 1080.0063



Non-return valve
SO - coupling

DN 10
Order code: 1080.0057
DN 12
Order code: 1080.0062
DN 20
Order code: 1080.0063

Adapter

DN 10 Muffe / M20x1,5 IG
(zur Verwendung mit
BVS u. IRMA System)

Artikle-Nr.: 1060.0582



Adapter

Female DN 10 / Female M20x1.5
(for use with BVS and IRMA
System)

Order code: 1060.0582

Einschraub- Muffe drehbar
Steck - O
DN 10 / G 1/4"
Artikel-Nr.: 1060.0035
DN 10 / G 3/8"
Artikel-Nr.: 1060.0009
DN 10 / G 1/2"
Artikel-Nr.: 1060.0253
DN 10 / G 3/4"
Artikel-Nr.: 1060.0443



Fixed female rotating
SO - coupling
DN 10 / BSP 1/4"
Order code: 1060.0035
DN 10 / BSP 3/8"
Order code: 1060.0009
DN 10 / BSP 1/2"
Order code: 1060.0253
DN 10 / BSP 3/4"
Order code: 1060.0443

Einschraub- Stecknippel drehbar
Steck - O
DN 20 / G 1/2"
Artikel-Nr.: 1060.0551
DN 20 / G 3/4"
Artikel-Nr.: 1060.0555



Male plug rotating
SO - coupling
DN 20 / BSP 1/2"
Order code: 1060.0551
DN 20 / BSP 3/4"
Order code: 1060.0555

Einschraub- Muffe drehbar
Steck - O
DN 12 / G 3/8"
Artikel-Nr.: 1060.0485
DN 12 / G 1/2"
Artikel-Nr.: 1060.0486
DN 12 / G 3/4"
Artikel-Nr.: 1060.0487



Fixed female rotating
SO - coupling
DN 12 / BSP 3/8"
Order code: 1060.0485
DN 12 / BSP 1/2"
Order code: 1060.0486
DN 12 / BSP 3/4"
Order code: 1060.0487

Verschlußmuffe
Steck - O
DN 10
Artikel-Nr.: 1060.0116
DN 12
Artikel-Nr.: 1060.0559
DN 20
Artikel-Nr.: 1060.0154



Female end cap
SO- coupling
DN 10
Order code: 1060.0116
DN 12
Order code: 1060.0559
DN 20
Order code: 1060.0154

Einschraub- Muffe drehbar
Steck - O
DN 20 / G 1/2"
Artikel-Nr.: 1060.0490
DN 20 / G 3/4"
Artikel-Nr.: 1060.0033

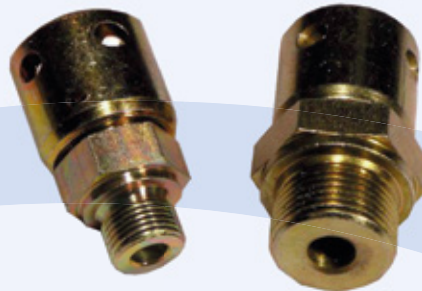

Fixed female rotating
SO - coupling
DN 20 / BSP 1/2"
Order code: 1060.0490
DN 20 / BSP 3/4"
Order code: 1060.0033

Verschlußstopfen
Steck - O
DN 10
Artikel-Nr.: 1060.0251
DN 12
Artikel-Nr.: 1060.0038
DN 20
Artikel-Nr.: 1060.0252



Male end plug
SO- coupling
DN 10
Order code: 1060.0251
DN 12
Order code: 1060.0038
DN 20
Order code: 1060.0252

Einschraub- Stecknippel drehbar Steck
- O
DN 10 / G 1/4"
Artikel-Nr.: 1060.0552
DN 10 / G 3/8"
Artikel-Nr.: 1060.0445
DN 10 / G 1/2"
Artikel-Nr.: 1060.0553
DN 10 / G 3/4"
Artikel-Nr.: 1060.0554



Male plug rotating
SO - coupling
DN 10 / BSP 1/4"
Order code: 1060.0552
DN 10 / BSP 3/8"
Order code: 1060.0445
DN 10 / BSP 1/2"
Order code: 1060.0553
DN 10 / BSP 3/4"
Order code: 1060.0554

T- Stück
Steck - O
DN 10-10-10
Artikel-Nr.: 1060.0027
DN 12-12-12
Artikel-Nr.: 1060.0471
DN 20-20-20
Artikel-Nr.: 1060.0472



Tee connector
SO - coupling
DN 10-10-10
Order code: 1060.0027
DN 12-12-12
Order code: 1060.0471
DN 20-20-20
Order code: 1060.0472

Einschraub- Stecknippel drehbar
Steck - O
DN 12 / G 1/2"
Artikel-Nr.: 1060.0557
DN 12 / G 3/4"
Artikel-Nr.: 1060.0558



Male plug rotating
SO - coupling
DN 12 / BSP 1/2"
Order code: 1060.0557
DN 12 / BSP 3/4"
Order code: 1060.0558

Doppelnippel
Steck - O
DN 10
Artikel-Nr.: 1060.0010
DN 12
Artikel-Nr.: 1060.0482
DN 20
Artikel-Nr.: 1060.0483



Double nipple
SO - coupling
DN 10
Order code: 1060.0010
DN 12
Order code: 1060.0482
DN 20
Order code: 1060.0483

Manometeranschluss
Steck - O

DN 10 / G 1/4" innen
Artikel-Nr.: 1060.0417
DN 12 / G 1/4" innen
Artikel-Nr.: 1060.0492



Gauge connector
SO - coupling

DN 10 / BSP 1/4" female Order
code: 1060.0417
DN 12 / BSP 1/4" female Order
code: 1060.0492

Reduzierstück

RD 32x1/8" / G 3/4"
Artikel-Nr.: 1060.0001
RD 32x1/8" / G 1"
Artikel-Nr.: 1060.0005



Reducer

RD 32x1/8" / BSP 3/4"
Order code: 1060.0001
RD 32x1/8" / BSP 1"
Order code: 1060.0005

Y - Schlauchverbinder
Steck - O

DN 10
Artikel-Nr.: 1060.0121
DN 12
Artikel-Nr.: 1060.0497



Y - hose coupling
SO - coupling

DN 10
Order code: 1060.0121
DN 12
Order code: 1060.0497

Usit - Ring
G 1/4"

Artikel-Nr.: 1040.0022
G 1/2"
Artikel-Nr.: 1040.0009
G 3/4"
Artikel-Nr.: 1040.0011
G 1"
Artikel-Nr.: 1040.0104



Gasket
BSP 1/4"

Order code 1040.0022
BSP 1/2"
Order code: 1040.0009
BSP 3/4"
Order code: 1040.0011
BSP 1"
Order code: 1040.0104

Gerade Muffe
Steck - O

DN 10 - 10
Artikel-Nr.: 1060.0097
DN 12 - 12
Artikel-Nr.: 1060.0011
DN 20 - 20
Artikel-Nr.: 1060.0496



Straight coupler
SO - coupling

DN 10 - 10
Order code: 1060.0097
DN 12 - 12
Order code: 1060.0011
DN 20 - 20
Order code: 1060.0496

Presseinband

DN 10
Artikel-Nr.: 1060.0564
DN 12
Artikel-Nr.: 1060.0565
DN 20
Artikel-Nr.: 1060.0566

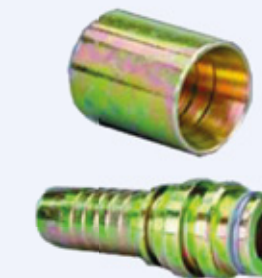

Press clamp

DN 10
Order code: 1060.0564
DN 12
Order code: 1060.0565
DN 20
Order code: 1060.0566

Einsteck T- Muffe drehbar
Steck - O

DN 10
Artikel-Nr.: 1060.0420



Plug in T - Coupler
rotating
SO - coupling

DN 10
Order code: 1060.0420

Einsteck Winkel - Muffe
drehbar
Steck - O

DN 10 - 10
Artikel-Nr.: 1060.0249
DN 12 - 12
Artikel-Nr.: 1060.0469
DN 20 - 20
Artikel-Nr.: 1060.0470



Plug in angle coupler
rotating
SO - coupling

DN 10 - 10
Order code: 1060.0249
DN 12 - 12
Order code: 1060.0469
DN 20 - 20
Order code: 1060.0470

Bohrlochverschluss
(Stahlinnenrohr)
BVS 32 St
Artikel-Nr.: 9200.0063
BVS 40 St
Artikel-Nr.: 9211.0002
BVS 54 St
Artikel-Nr.: 9225.0053



Borehole Seals
(inside steel pipe)
BVS 32 St
Order code: 9200.0063
BVS 40 St
Order code: 9211.0002
BVS 54 St
Order code: 9255.0053

Injektionspacker Stahl
mechanisch

10mm x 115mm
Artikel-Nr.: 9200.0043
13mm x 145mm
Artikel-Nr.: 9200.0044
17mm x 145mm
Artikel-Nr.: 9200.0045



Injectionpacker Steel
mechanic

10mm x 115mm
Order code: 9200.0043
13mm x 145mm
Order code: 9200.0044
17mm x 145mm
Order code: 9200.0045

Bohrlochverschluss
(Kunststoffinnenrohr)
BVS 40 K
Artikel-Nr.: 9209.0002
BVS 54 K
Artikel-Nr.: 9200.0054
BVS 54 KD (Doppel- BVS)
Artikel-Nr.: 9200.0068



Borehole Seals
(inside plastic pipe)
BVS 40 K
Order code: 9209.0002
BVS 54 K
Order code: 9200.0054
BVS 54 KD (Double- BVS)
Order code: 9200.0068

Injektionspacker Stahl
mechanisch

19mm x 200mm
Artikel-Nr.: 9200.0046
23mm x 200mm
Artikel-Nr.: 9200.0036
25mm x 200mm
Artikel-Nr.: 9200.0037



Injectionpacker Steel
mechanic

19mm x 200mm
Order code: 9200.0046
23mm x 200mm
Order code: 9200.0036
25mm x 200mm
Order code: 9200.0037

Bohrlochverschluss
BVS 40 M
(Stahlinnenrohr)
inkl. Statikmischer
Artikel-Nr.: 9200.0030



Borehole Seal
BVS 40 M
(inside steel pipe)
inkl. staticmixer
Order code: 9200.0030

Injektionspacker Messing
rostfrei, mechanisch
10mm x 115mm
Artikel-Nr.: 0000.0000
13mm x 145mm
Artikel-Nr.: 0000.0000
17mm x 145mm
Artikel-Nr.: 0000.0000
19mm x 200mm
Artikel-Nr.: 0000.0000



Injectionpacker Brass
stainless, mechanic
10mm x 115mm
Order code: 0000.0000
13mm x 145mm
Order code: 0000.0000
17mm x 145mm
Order code: 0000.0000
19mm x 200mm
Order code: 0000.0000

BVS 40 Z
für Zement Injektionen
Artikel-Nr.: 9200.0092

BVS 40 Z
for cementitious grout
Order code: 9200.0092

Adapter Schlauch für
Injektionspacker Stahl
mechanisch

300mm
Artikel-Nr.: 9200.0038



Adapter hose for
Injektionspacker Steel
mechanic

300mm
Order code: 9200.0038

Adapter DN 10 / G 1/4"
Artikel-Nr.: 1060.0035

Packer L 500
43 mm
Artikel-Nr.: 0000.0000
54 mm
Artikel-Nr.: 0000.0000
73 mm
Artikel-Nr.: 0000.0000
88 mm
Artikel-Nr.: 0000.0000
102 mm
Artikel-Nr.: 9200.0039



Adapter DN 10 / BSP 1/4"
Order code: 1060.0035

Packer L 500
43 mm
Order code: 0000.0000
54 mm
Order code: 0000.0000
73 mm
Order code: 0000.0000
88 mm
Order code: 0000.0000
102 mm
Order code: 9200.0039

Druckschlauch für
Packer L500
Polyamid 6/3

G 1/2 innen
Artikel-Nr.: 9200.0040



Inflationhose for
Packer L500
Polyamid 6/3

G 1/2 female
Order code: 9200.0040

Pumpe für Packer L 500
25 bar
Artikel-Nr.: 9200.0041



Pump for Packer L 500
25 bar
Order code: 9200.0041

Container 45l
Order code: 9200.0042

Behälter 45l
Artikel-Nr.: 9200.0042

Beschickungsrohr m. Griff
1000mm
Artikel-Nr.: 9403.0077
1500mm
Artikel-Nr.: 9403.0078
2000mm
Artikel-Nr.: 9403.0070
2500mm
Artikel-Nr.: 9403.0063



Feeder pipe w. Handlebar
1000mm
Order code: 9403.0077
1500mm
Order code: 9403.0078
2000mm
Order code: 9403.0070
2500mm
Order code: 9403.0063

Beschickungsrohr
1000mm
Artikel-Nr.: 9401.0102
1500mm
Artikel-Nr.: 9401.0103
2000mm
Artikel-Nr.: 9403.0052
2500mm
Artikel-Nr.: 9401.0101



Feeder pipe
1000mm
Order code: 9401.0102
1500mm
Order code: 9401.0103
2000mm
Order code: 9403.0052
2500mm
Order code: 9401.0101

Beschickungsrohr Kunststoff
1000mm
Artikel-Nr.: 9400.0042
1500mm
Artikel-Nr.: 9400.0032
2000mm
Artikel-Nr.: 9400.0014
2500mm
Artikel-Nr.: 9400.0033

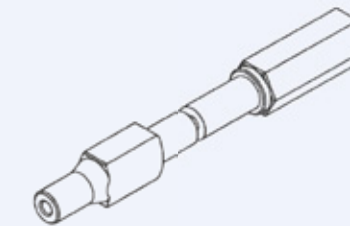

Feeder pipe plastic
1000mm
Order code: 9400.0042
1500mm
Order code: 9400.0032
2000mm
Order code: 9400.0014
2500mm
Order code: 9400.0033

Rammlanzen
1/4" / 1000mm

Rammlanze
Artikel-Nr.: 9500.0057
Verlängerung m. Bohrungen
Artikel-Nr.: 9500.0055
Verlängerung o. Bohrungen
Artikel-Nr.: 9500.0053

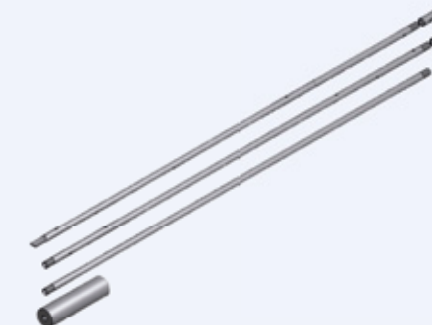

Injection lance
1/4" / 1000mm

Injection lance
Order code: 9500.0057
Perforated Extension
Order code: 9500.0055
Unperforated Extension
Order code: 9500.0053

Rammlanzen Zubehör
1/4"
Aufschraubmuffe 1/4" zu Steck-O
DN10 Muffe
Artikel-Nr.: 1060.0687
Verbindungs muffen
Artikel-Nr.: 9500.0051
Rammblock
Artikel-Nr.: 9500.0050

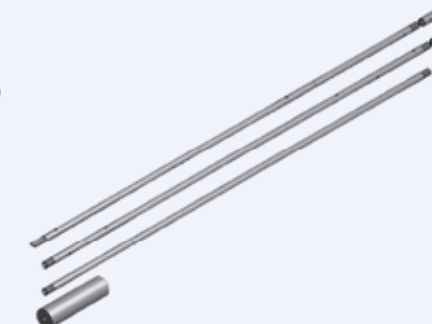

Injection lance accessories
1/4"
Adapter Female 1/4" to Female
Steck-O DN10
Order code: 1060.0687
Straight couplers
Order code: 9500.0051
Ram block
Order code: 9500.0050

Wetterdüsen
W20
Artikel-Nr.: 0100.0010
W40
Artikel-Nr.: 0100.0108
W70
Artikel-Nr.: 0100.0003
W70F
Artikel-Nr.: 0100.0006

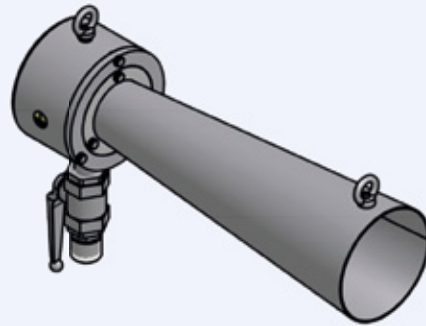

Air Mover
W20
Order code: 0100.0010
W40
Order code: 0100.0108
W70
Order code: 0100.0003
W70F
Order code: 0100.0006

Ankerbohrsäule
BAS 3,0/600-D2800
Artikel-Nr.: 8411.0500
BAS 3,0/600-D3600
Artikel-Nr.: 8411.0600
BAS 3,0/600-D4500
Artikel-Nr.: 8411.0400



Roofbolter
BAS 3,0/600-D2800
Order code: 8411.0500
BAS 3,0/600-D3600
Order code: 8411.0600
BAS 3,0/600-D4500
Order code: 8411.0400

Falls das von Ihnen gewünschte Produkt die Artikel- Nummer 0000.0000 aufweist, setzen Sie sich bitte mit uns für ein individuelles Angebot in Verbindung.

If you want to purchase a product with the order code of 0000.0000 please feel free to call us for an individual offer.





Bei dem Gerichte
37445 Walkenried
Germany
Tel.: +49 5525 201 - 0
Fax: +49 5525 201 - 48
E-Mail: info@mtsperforator.de
www.mtsperforator.de

Am Heisterbusch 18 a
19246 Lüttow-Valluhn
Germany
Tel.: +49 38851 327 - 0
Fax: +49 38851 327 - 10
E-Mail: info@mtsperforator.de
www.mtsperforator.de